

LECCIÓN
5

LA ARMADURA DE DIOS

ARMADOS PARA LA BATALLA

• EFESIOS 6:18 •

1.- MARQUE LA ALTERNATIVA CORRECTA

1.1 ¿Qué debes hacer para que la armadura te proteja?

Colocártela

Shazam

Orar

1.2 ¿Cada cuanto tiempo deberías de orar?

Los domingos

Cuando me vaya mal

En todo momento

1.3 ¿Cómo describe Santiago la oración del justo (SANTIAGO 5:13-16)?

Poderosa y eficaz

Floja

Puede ser mejor

1.4 ¿Qué debemos de confesar?

Mentiras blancas

Nuestros pecados

Los pecados ajenos

2.- VERDADERO O FALSO

2.1 ___ Una de las partes de la armadura de Dios es el cinturón del cahuín.

2.2 ___ Otras de las partes de la armadura es el yelmo de la salvación.

2.3 ___ Nosotros debemos orar por todas las cosas, por los creyentes, por las necesidades.

2.4 ___ Solamente debemos de orar, cuando nos va mal en la vida.

2.5 ___ Abraham fue un ejemplo de oración.

3.- ESCRIBE LAS PARTES DE LA ARMADURA

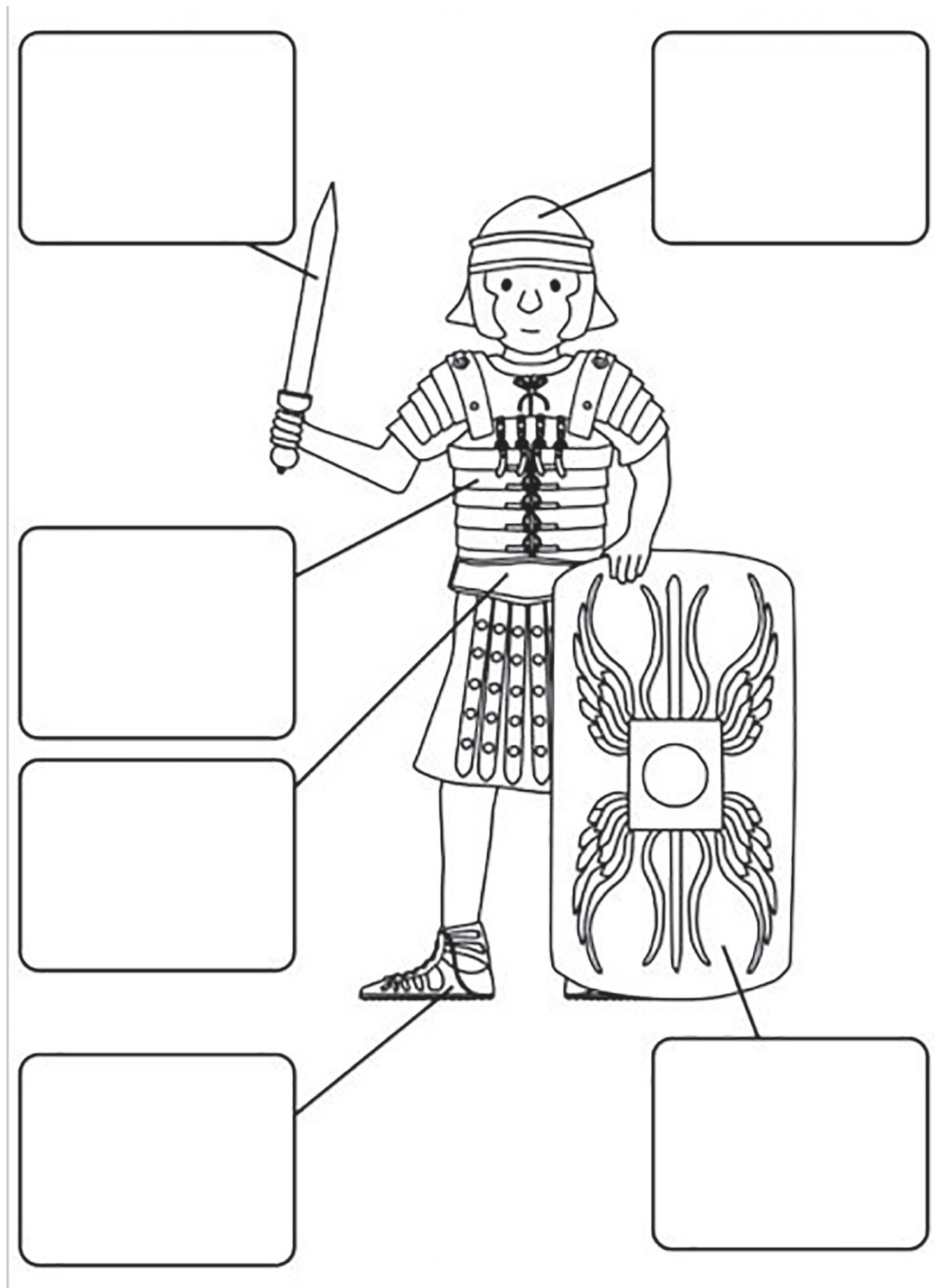

4.- SOPA DE LETRA

Busca las siguientes palabras:

CINTURON - SALVACION - CORAZA - ESCUDO - JUSTICIA - ZAPATOS
CASCO - ESPIRITU - PAZ - ESPADA - FE - VERDAD

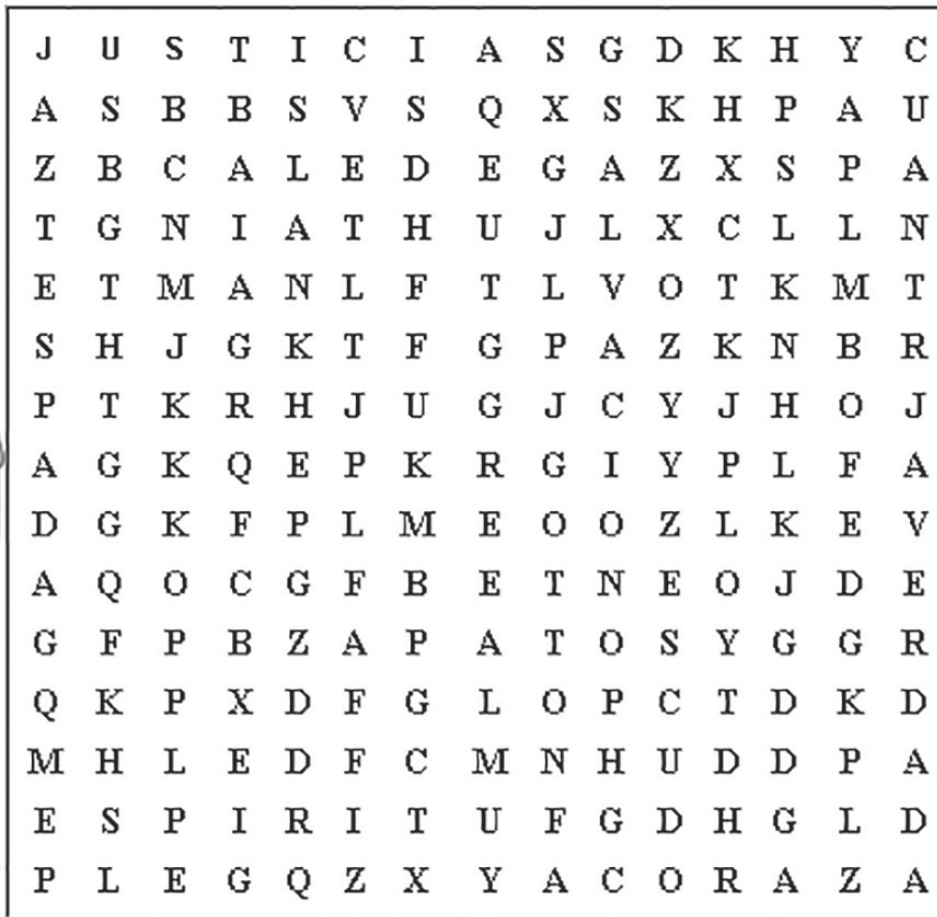

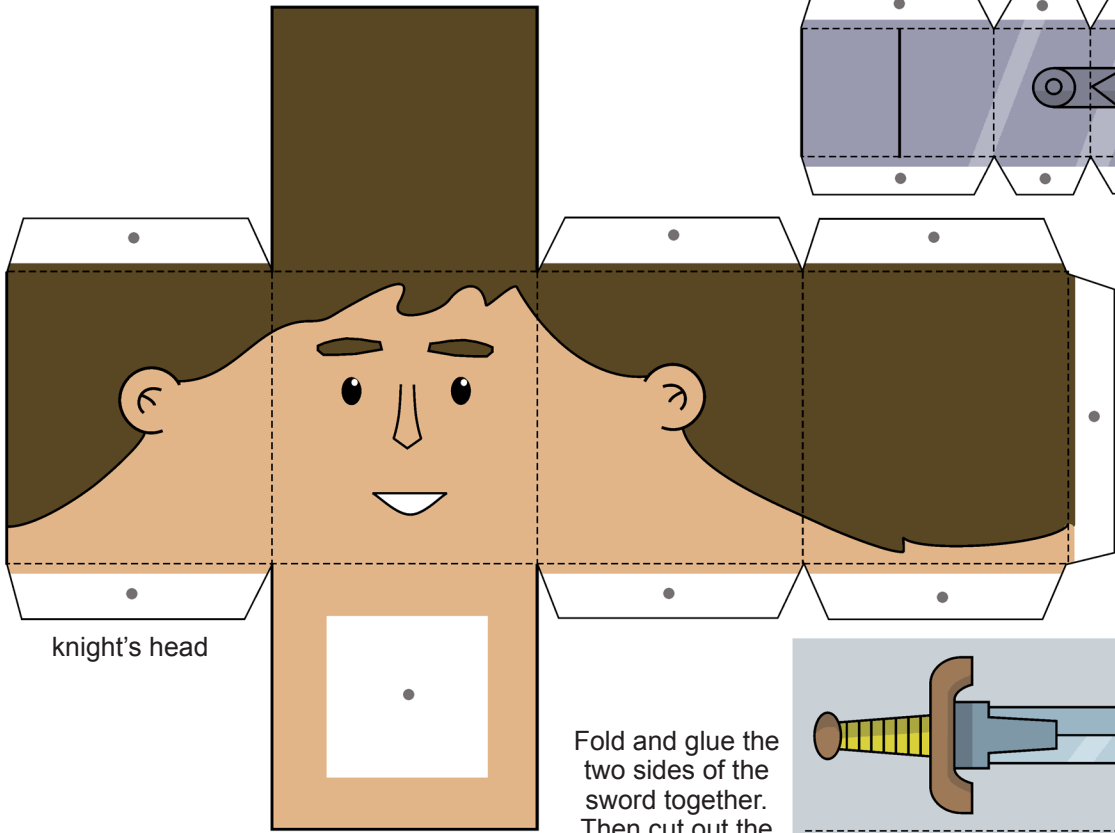

knight's head

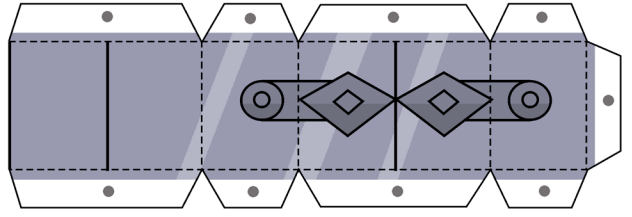

knight's legs

Fold and glue the two sides of the sword together. Then cut out the sword by cutting along the lines of the sword.

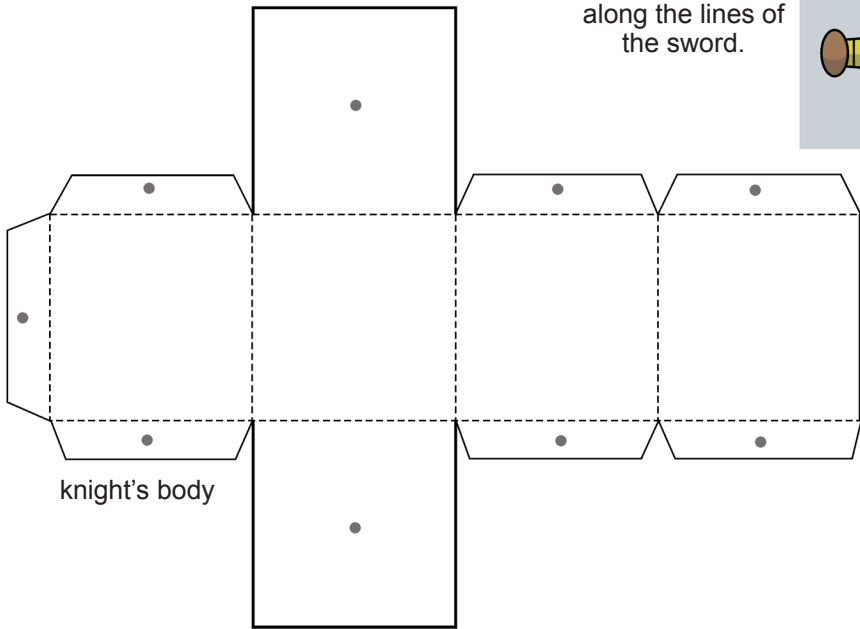
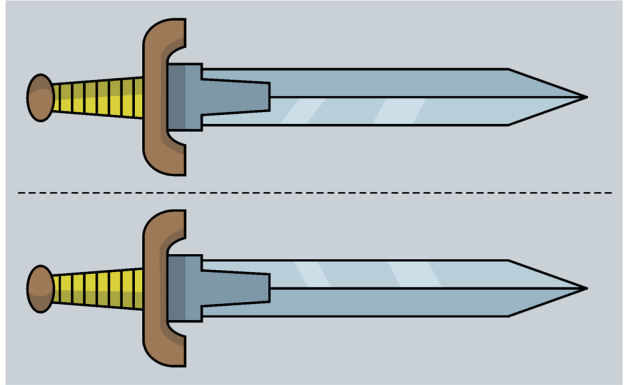

knight's body

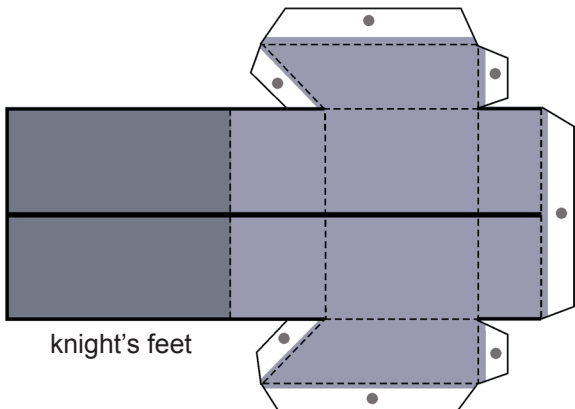
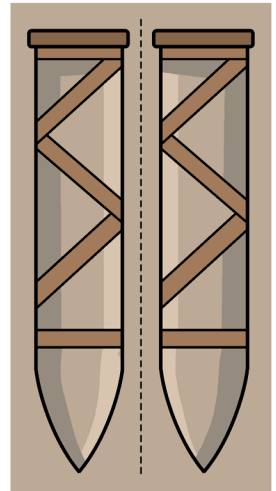

knight's feet

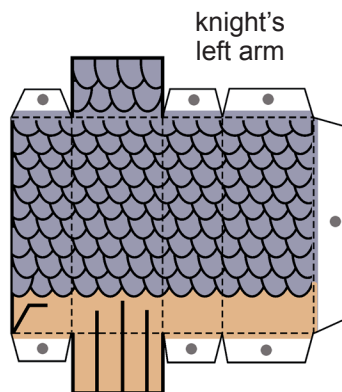

knight's left arm

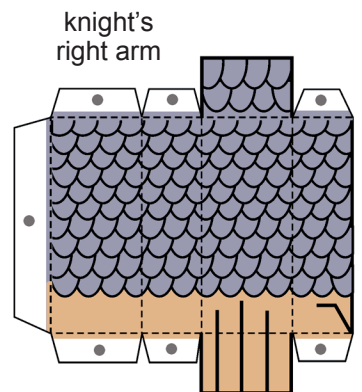

knight's right arm

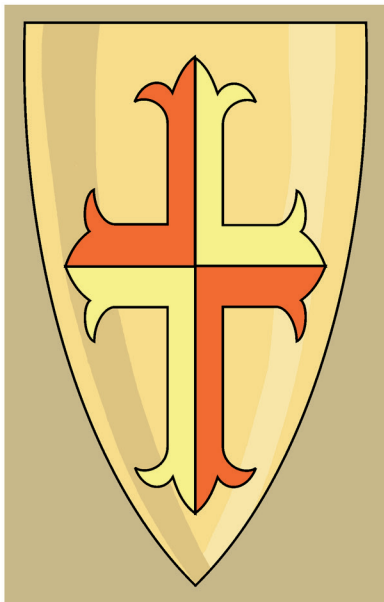

knight's shield

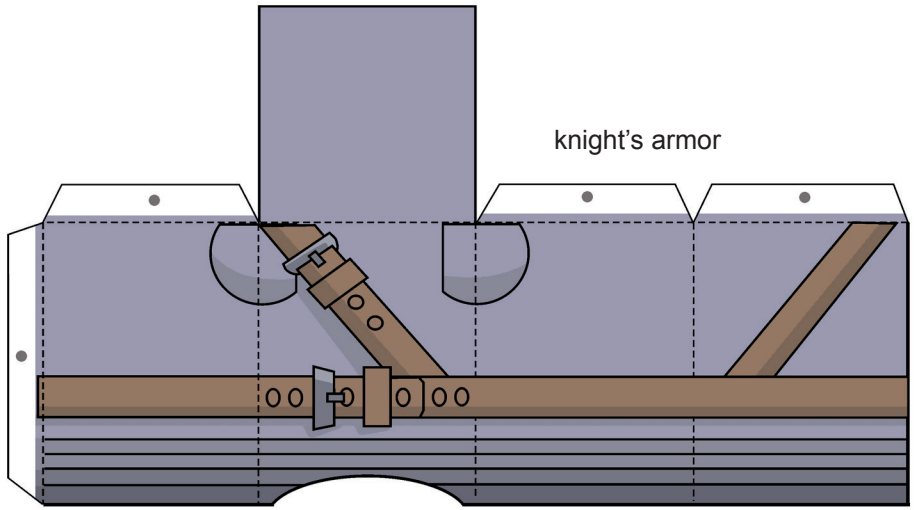

knight's armor

pieces for attaching the arms to the body

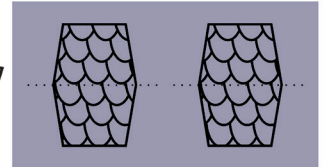

knight's helmet

tabs to attach the tuft on the helmet

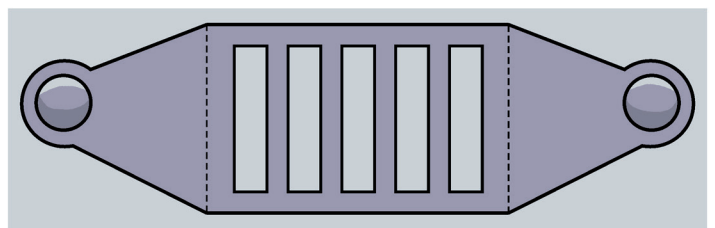
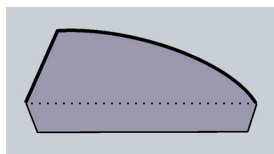
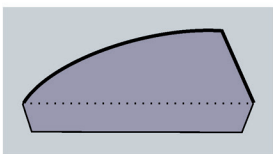
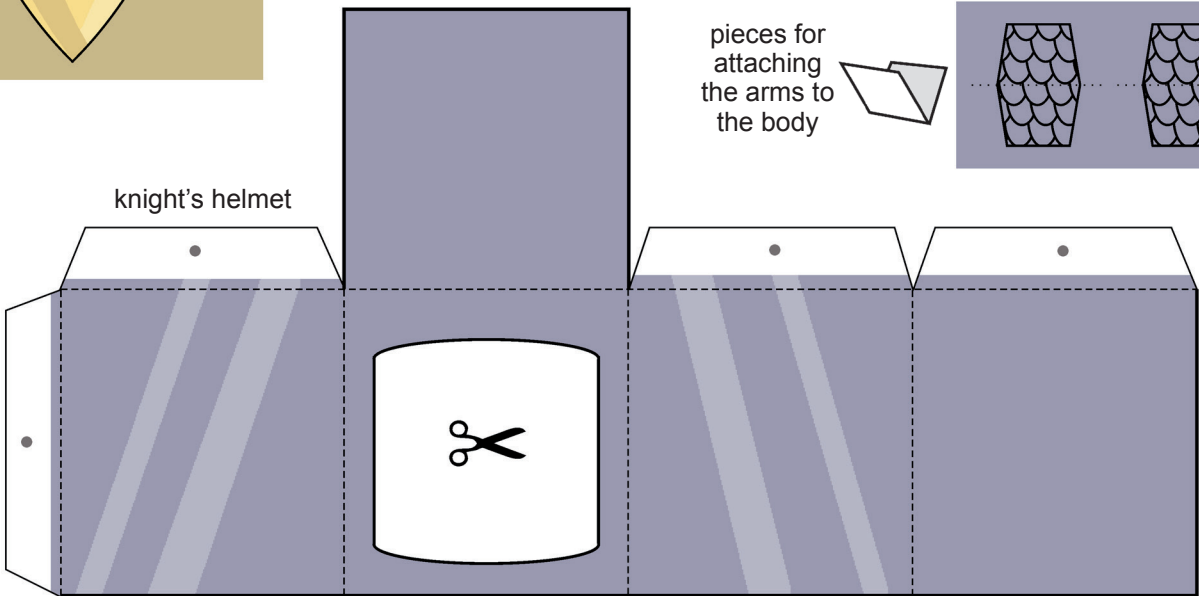

knight's helmet visor

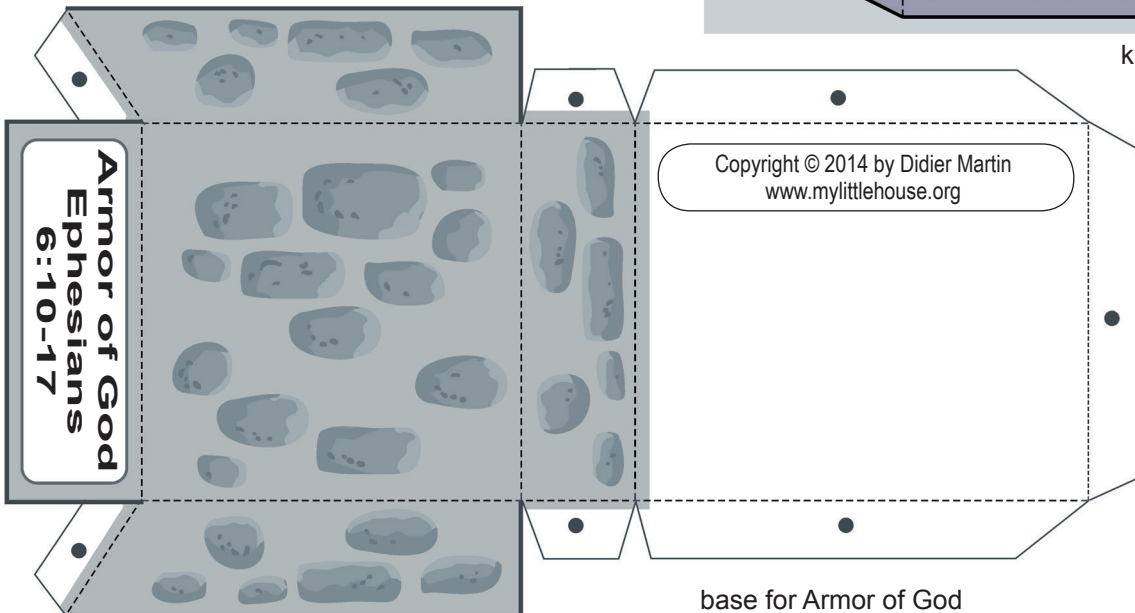

**Armor of God
Ephesians
6:10-17**

Copyright © 2014 by Didier Martin
www.mylittlehouse.org

base for Armor of God

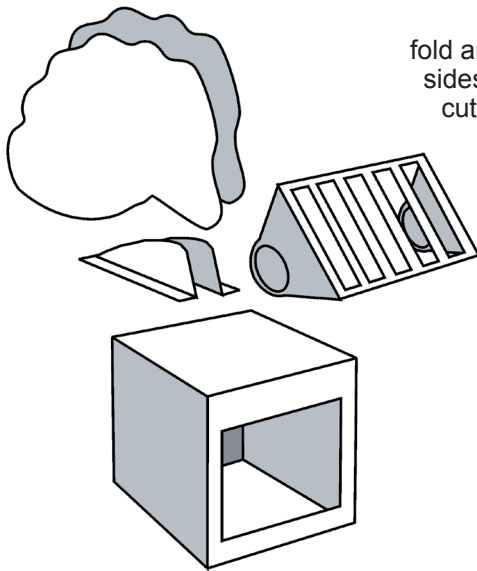

helmet tuft
fold and glue the two
sides together, then
cut along the lines

TO ADD THE CREST TO THE HELMET
Cut out and assemble the helmet box and visor. Cut out the two parts of the tuft. Also, cut out the two tabs for attaching the tufts found on page 3. Glue the tufts and tabs sandwiched together with the tufts in the middle. Next, glue the assembled crest on top of the helmet. See the photos on the cover for the example.

Extra tabs to use
for the front of the
base to write your
own text.

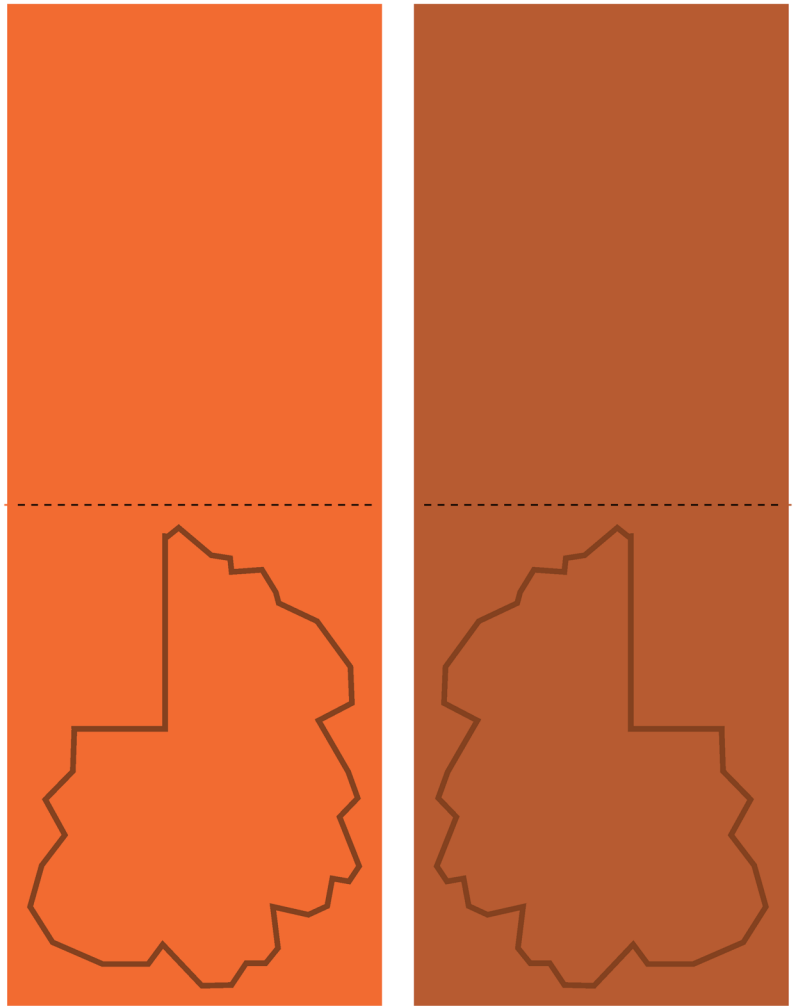

Print this page on
regular weight paper

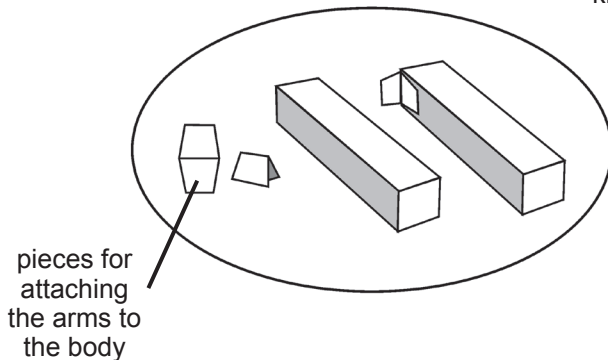

pieces for
attaching
the arms
to the
body

